

HUEGLI TECH AG (LTD)

The Engine & Genset Control Company

1. Speed Governing
- 2. Genset Automation**
3. Hydraulic Cranking
4. Engine Protection

InteliGen®



**Unbeatable solution for total
generating set control**

InteliGen features...

As everybody does....

Engine and genset sequencing, monitoring and protection

plus

- Measurement Center of complete genset data
- Remote control from 2 places plus GSM support
- Complete history for failure tracing „black-box“
- Modular concept to adapt to various applications
- Power management up to 32 sets, „no master system“
- Free control and multiset SCADA software

For applications of gensets in...

- Single and parallel installations
- Telecommunications industry
- Police sub-stations
- Military environment
- Rental business
- Service contracts

- and many others!

IG - Instant switchboard savings!

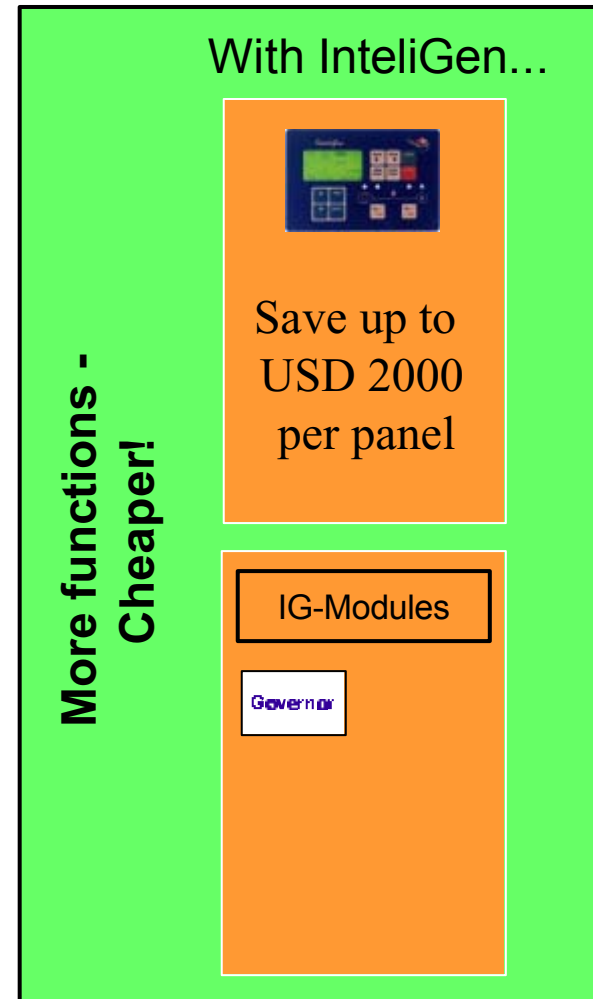
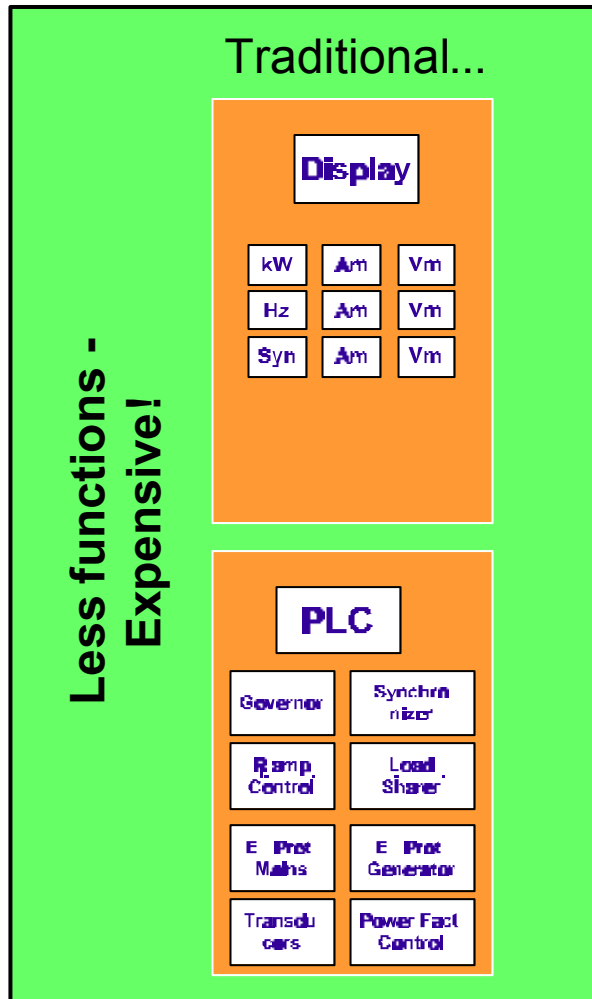

Synchronisation panel philosophies

	Control Unit	PLC	Protection relays	Relays	Transducers	PF/VAR control	Synchroniser	Load Sharaer	Panel Meters	SW Engineering	
Traditional Method	x	x	x	x	x	x	PLC		x	x	
Semi-integration	x	(x)	x	x	x	x	x	x	x	x	
Full integration IntelliGen	x	no	no	x	no	no	modules		no	no	

Advantages over PLC

No PLC & software programs needed

„We need special functions“

Usually most of „special functions“ are implemented in ComAp's controllers

„We need a cheaper PLC solution“

The total sum of all components is usually higher than a dedicated controller

„We do not want all-in-one solution“

The distributed solution is less reliable

„We have a lot of different applications“

Configuration is a powerful tool for such requirements

-
-
-
-
-
-
-
-
-
-

InteliGen - A powerful tool!

-
-
-
-
-
-
-
-



From simple applications...

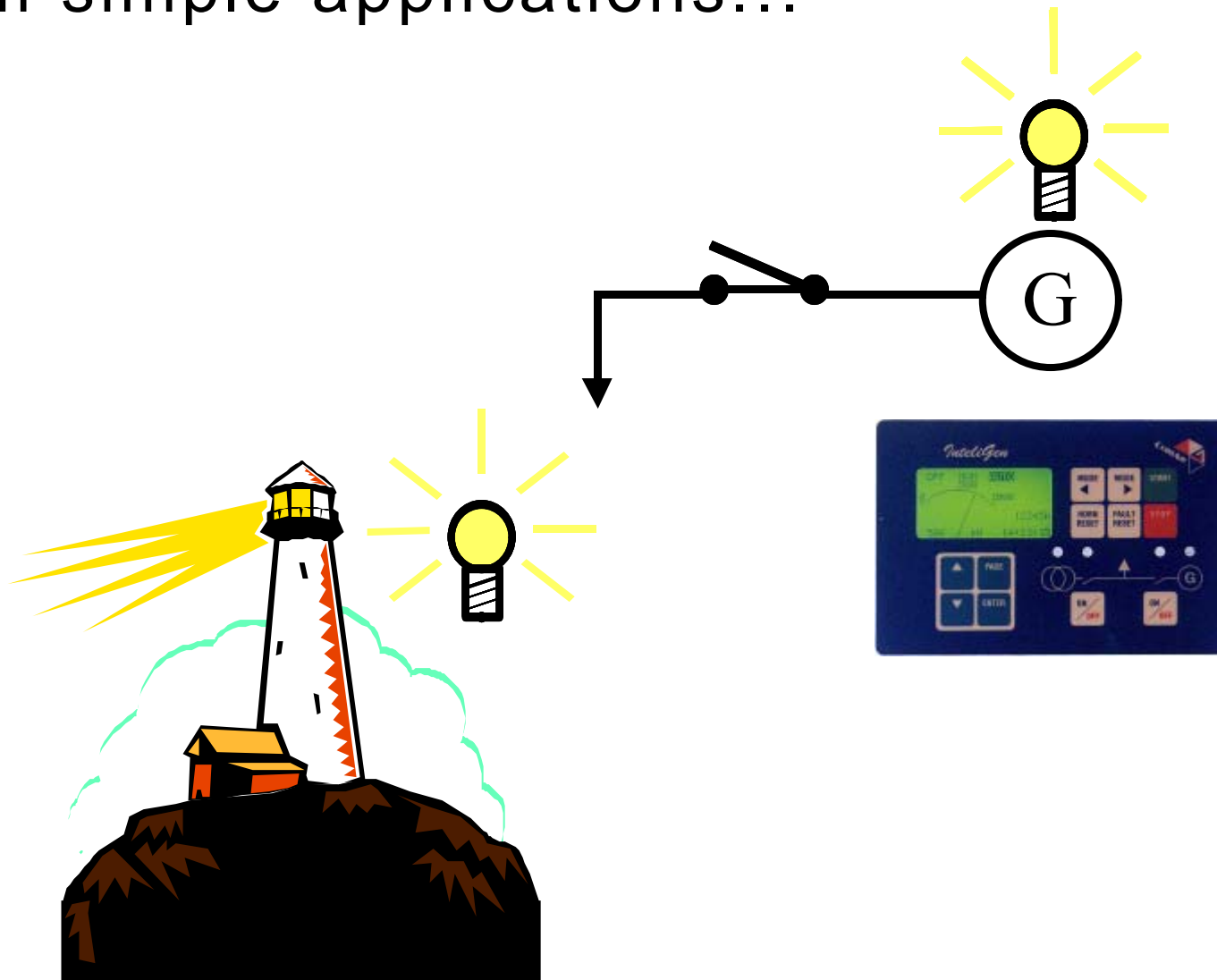

To very complex ones...

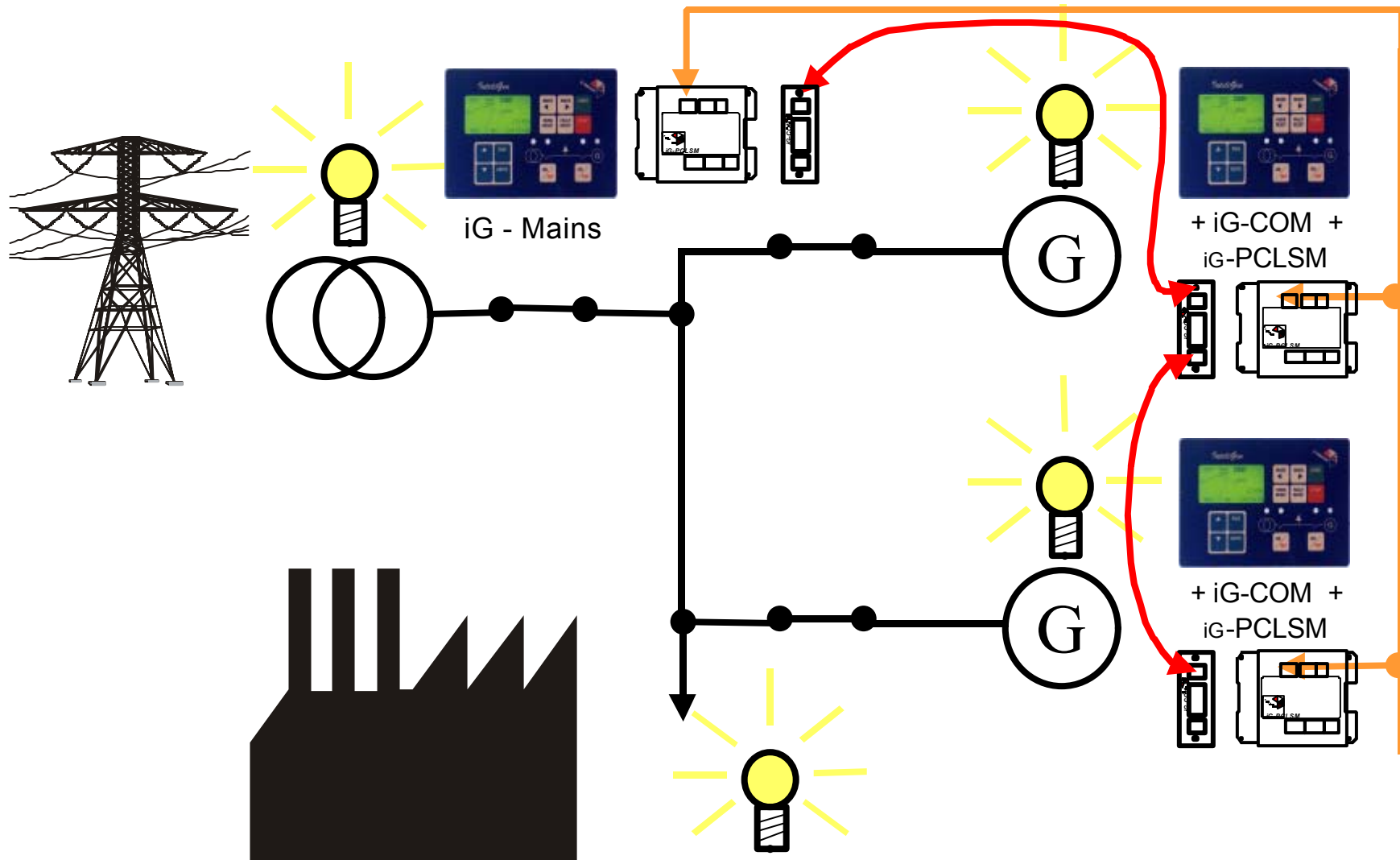

-
-
-
-
-
-
-
-
-
-

Perfect communication possibilities

-
-
-
-
-
-
-
-



Total communication

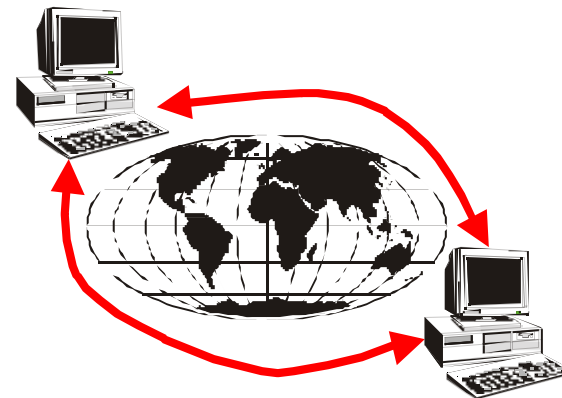
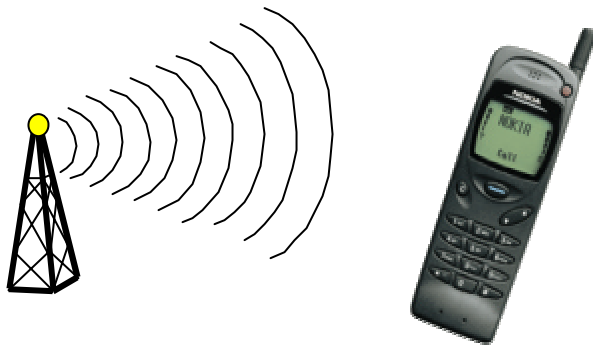
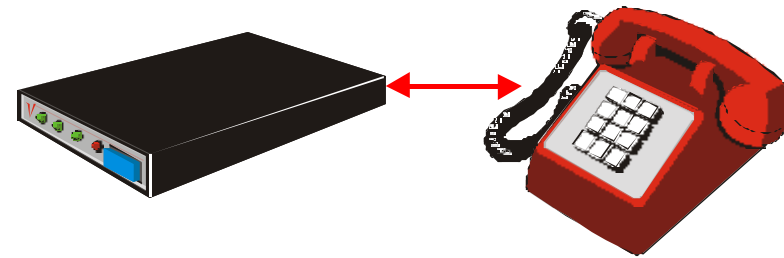

IG-COM supports:

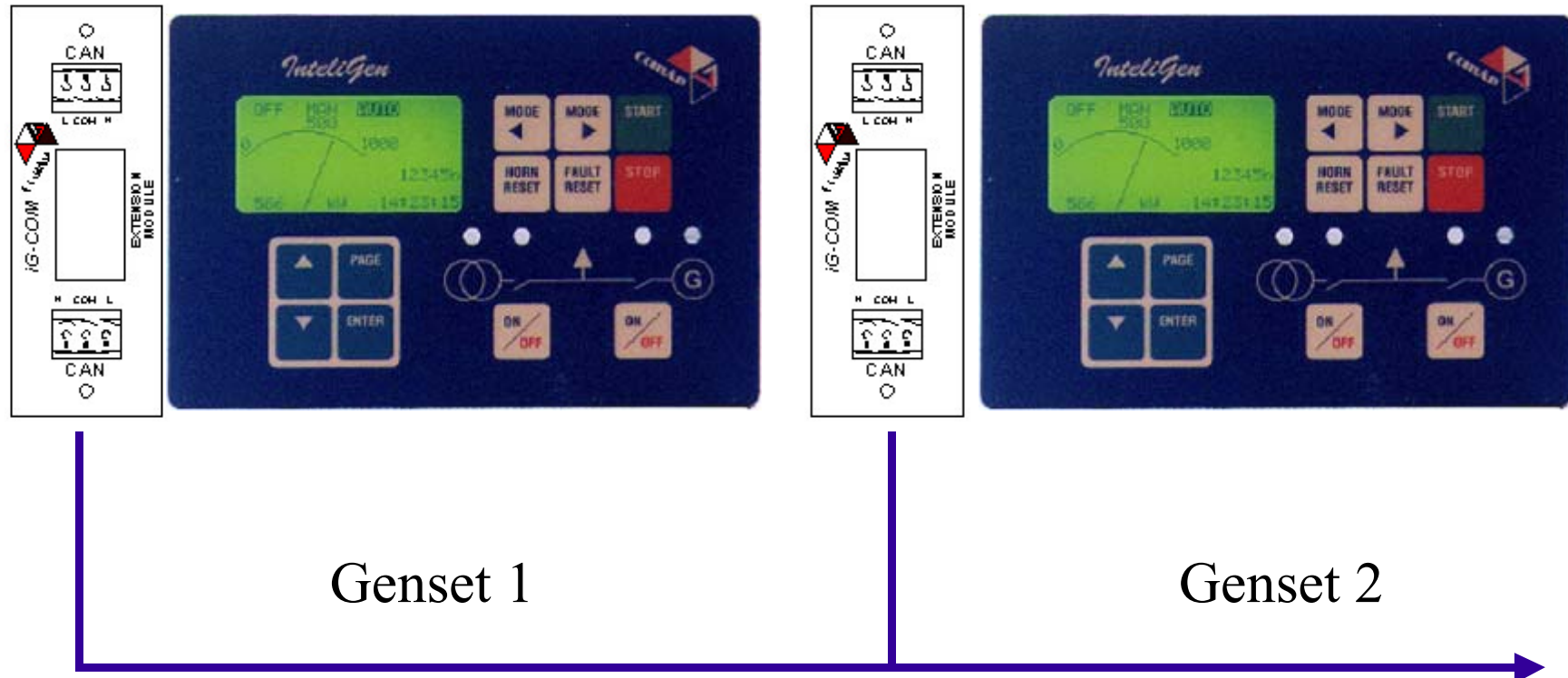

- Power Management and multi set remote control
- No master system

-
-
-
-
-
-
-
-
-
-

**Power Factor Control - VAR Sharing
No Problem!**

-
-
-
-
-
-
-
-



IG-PC(LS)M + IG-AVRi: PF/VAR Control

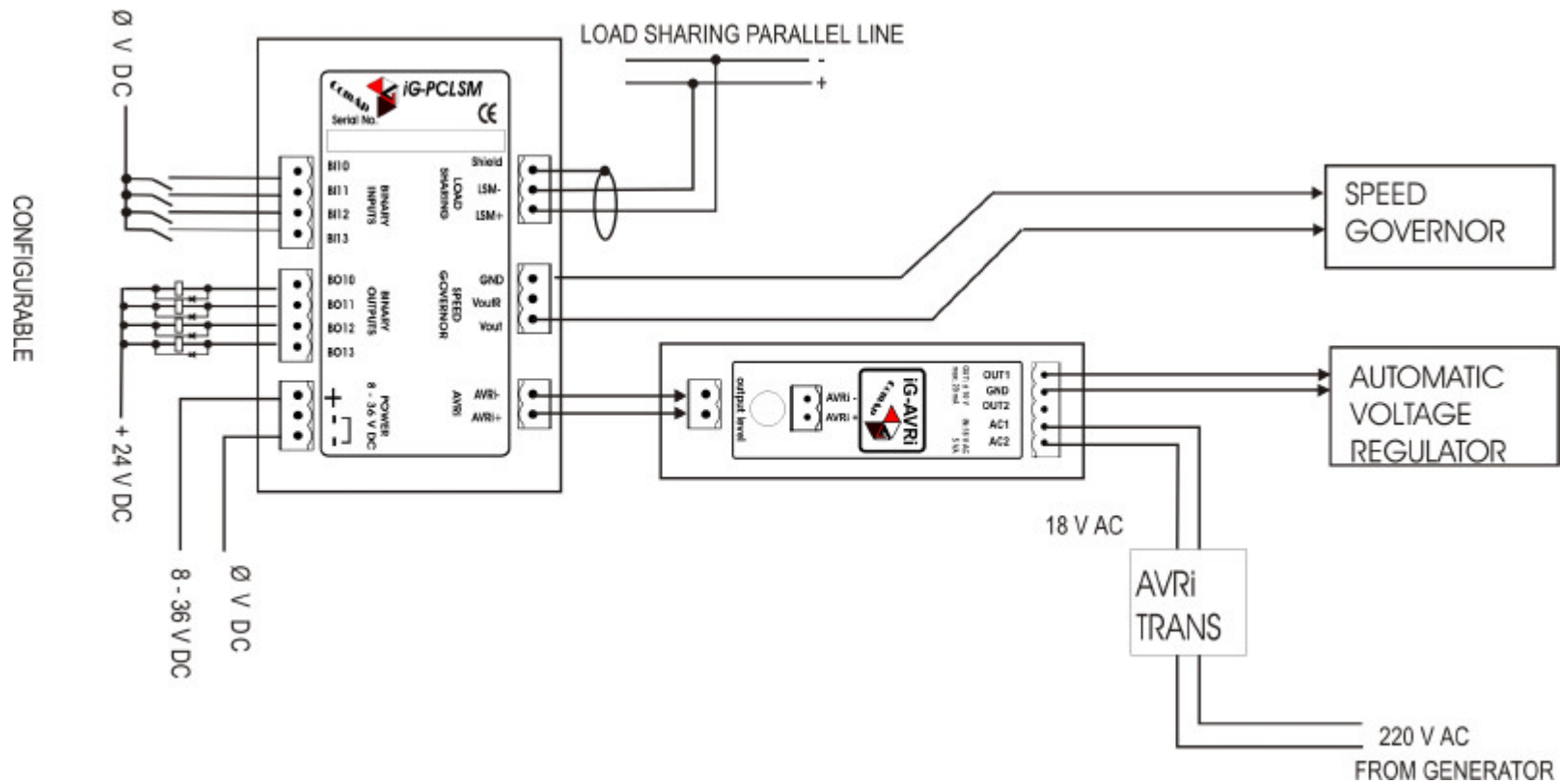

-
-
-
-
-
-
-
-
-
-

Need more inputs and outputs? - IG-IOM

-
-
-
-
-
-
-
-



IG-IOM

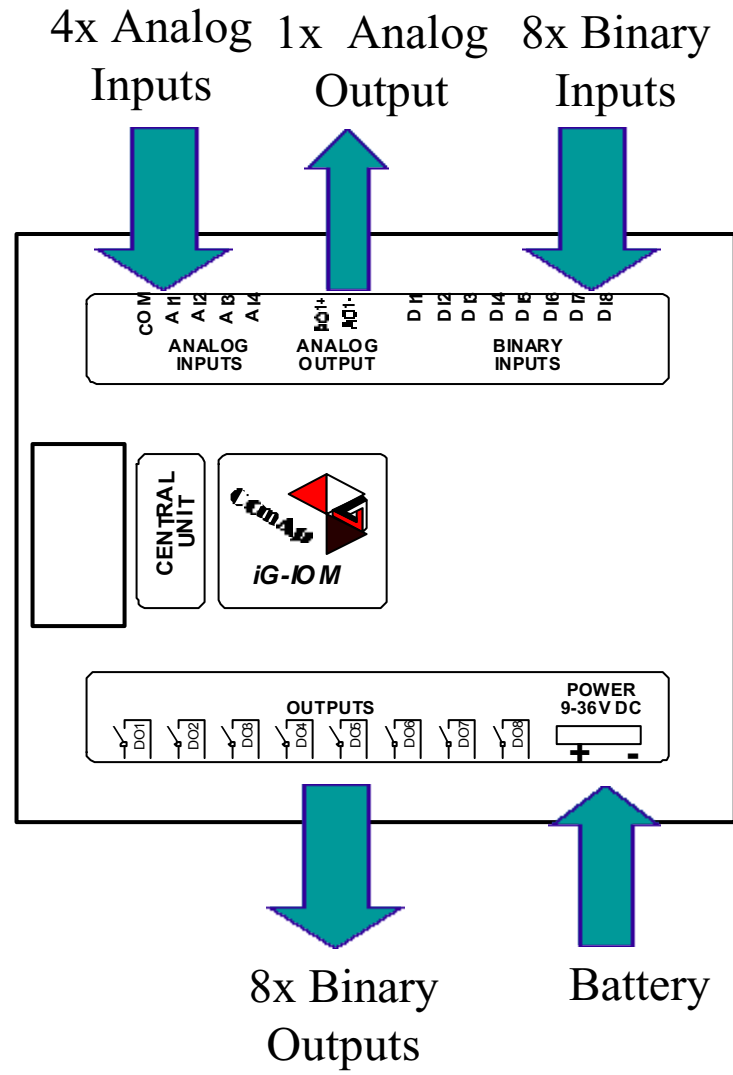

IG-PC(LS)M: Link to Speed Governor

- Configurable output for speed governors
- CAN Bus interlink for new engines under preparation

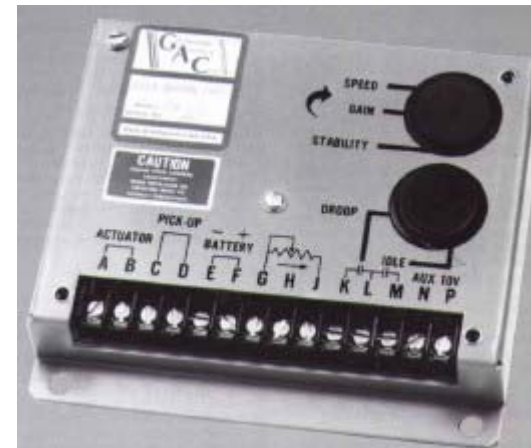
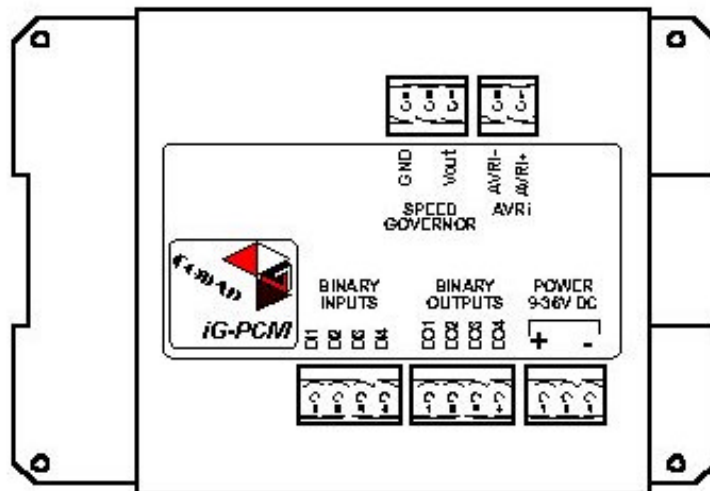

IG - Instant switchboard savings!

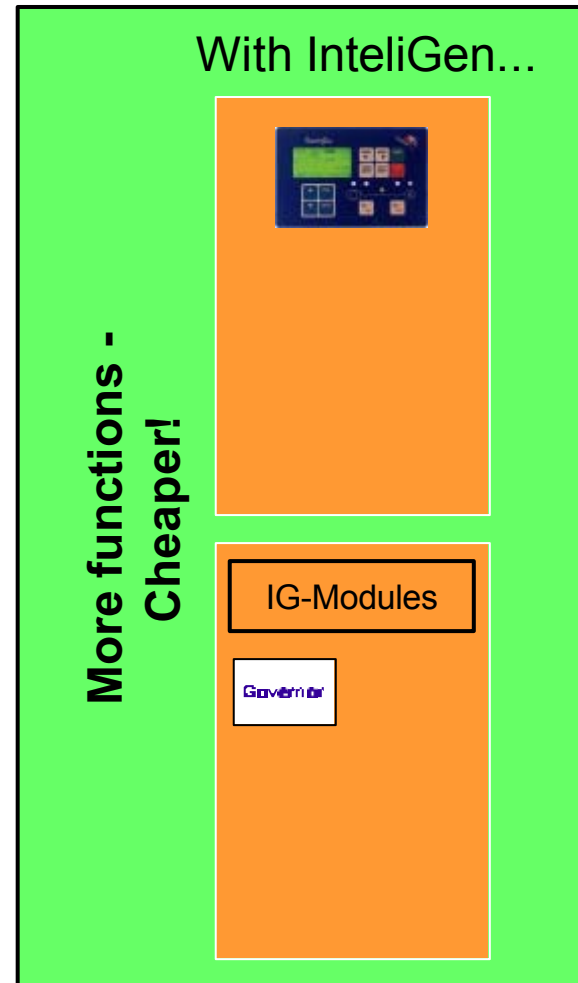
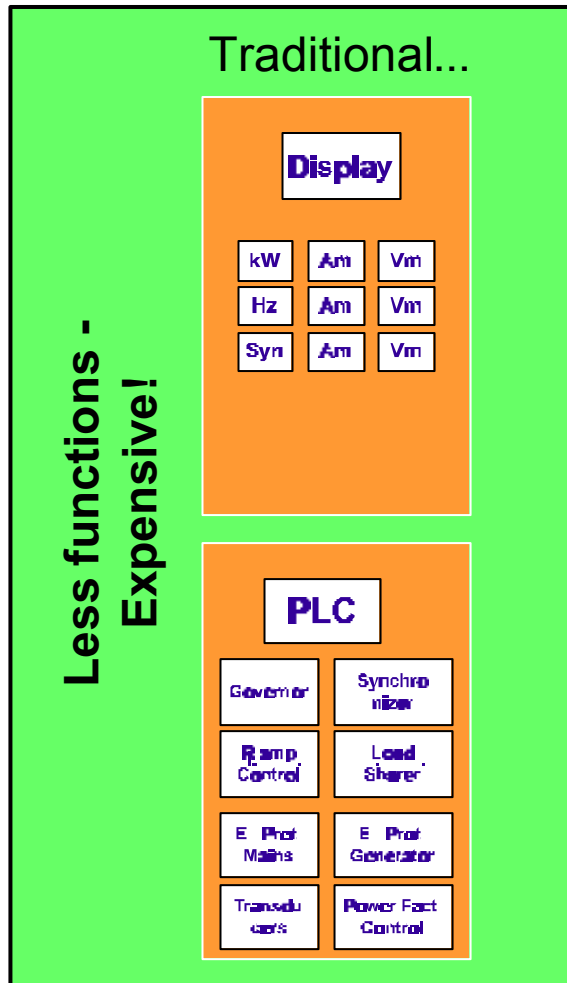



HUEGLI TECH AG (LTD)
The Engine & Genset Control Company

Applications AMF Panel



Applications Isolated Parallel





HUEGLI TECH AG (LTD)
The Engine & Genset Control Company

Ghana, 21x600kW parallel



Ghana, control panels





HUEGLI TECH AG (LTD)
The Engine & Genset Control Company

-
-
-
-
-
-
-
-
-

InteliSys

-
-
-
-
-
-
-
-



InteliSys advantages over InteliGen

- Increase the number of inputs and outputs
- Longer history file + post mortem history
- Bigger graphical display
- SW configurable analogue inputs
- More computing power for complex applications
- High voltage measurement (PT ratio)
- Building management functions (PLC)

Power Range IG/IS Controller

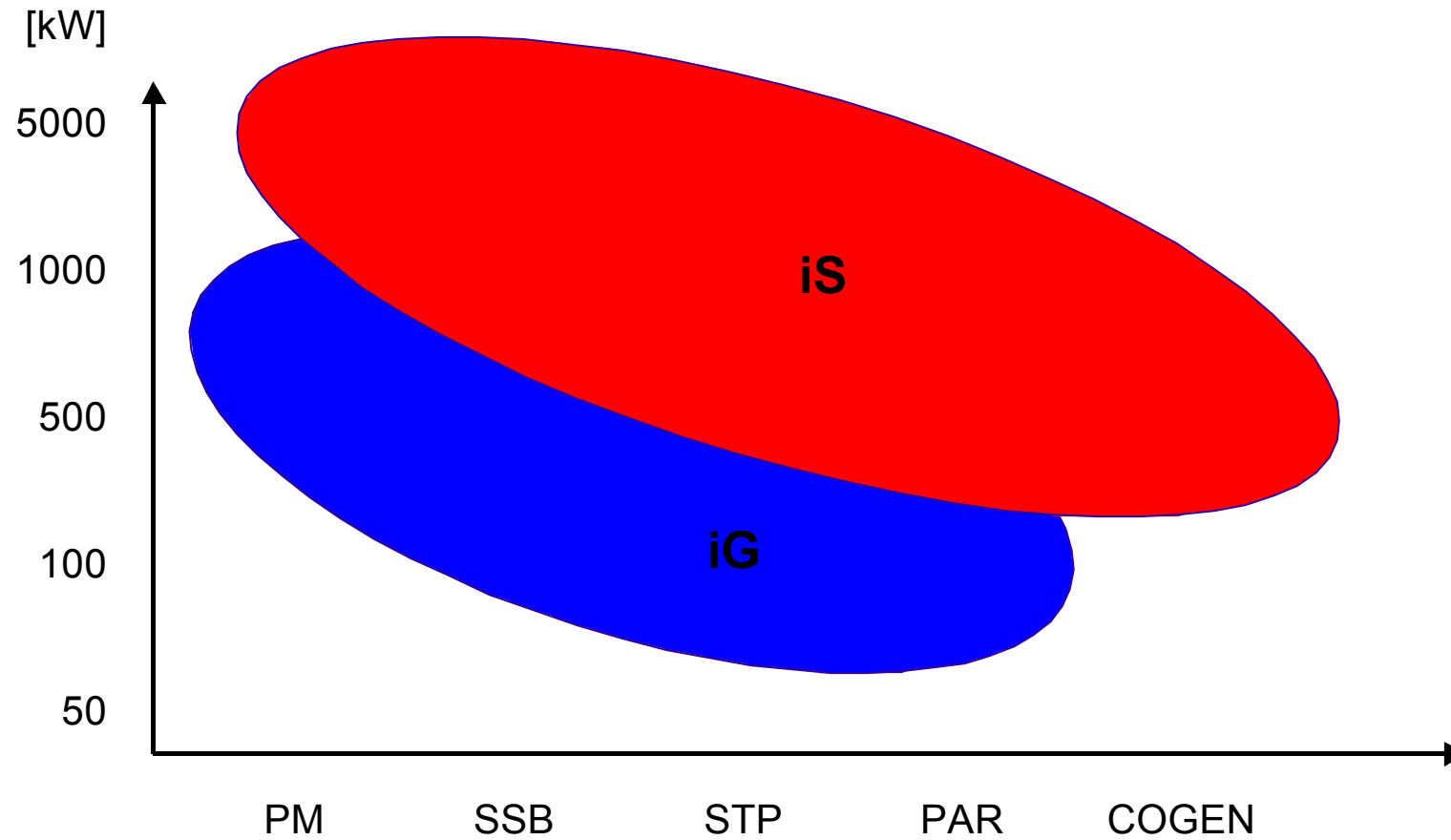

InteliGen®



CONVINCED?
QUESTIONS?
TRY US!